

NUS-IDS at CASE 2021 Task 1: Improving Multilingual Event Sentence Coreference Identification with Linguistic Information

Fiona Anting Tan, Sujatha Das Gollapalli, See-Kiong Ng
Institute of Data Science
National University of Singapore, Singapore
tan.f@u.nus.edu, idssdg@nus.edu.sg, seekiong@nus.edu.sg

ACL-CASE 2021 (Hurriyetoglu et al., 2021)

<i>Article ID: 55328</i>		Event Clusters: [[2],[1,7]]
1	"Farmers Block NH 7 , Say Government Blind to Their Plight 21st June 2015 06:00 AM CHIKBALLAPUR : Farmers on Saturday blocked the busy National Highway 7 on the outskirts of the city for nearly five hours and shouted slogans against the Union and state governments ."	
2	"Earlier , they staged a protest in front of the office of the Deputy Director of Sericulture here and took out a procession ."	
7	"Following the protest , traffic on the highway was paralysed for some time ."	

Obs Unit	English	Portuguese	Spanish
Train			
Articles	596	21	11
Sentences	2581	88	45
Pairs	6241	235	86
Test			
Articles	100	40	40
Sentences	486	144	188
Pairs	1554	257	549

Table 1: Number of observations at different unit levels for train and test set

Our approach

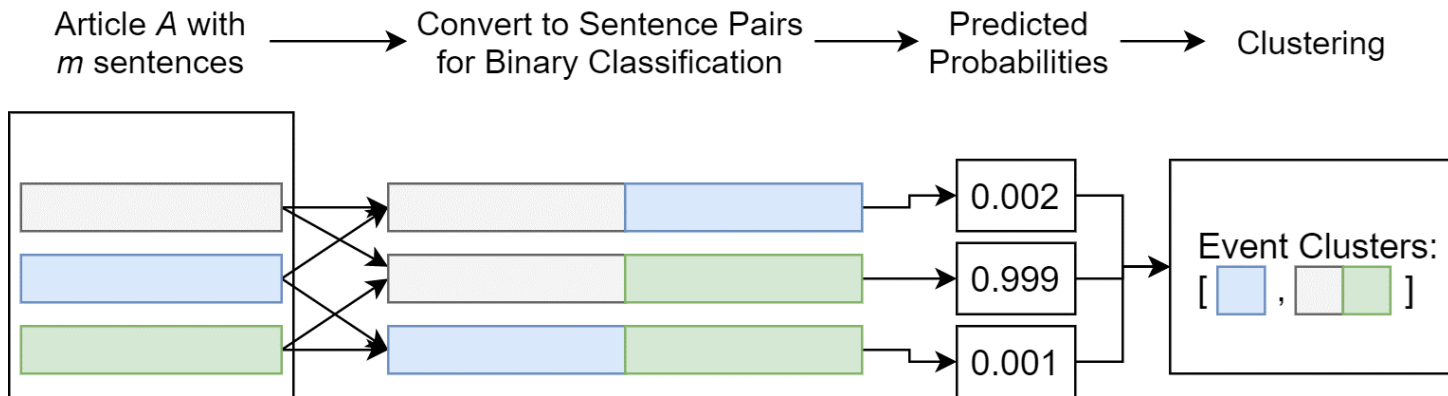

Our approach

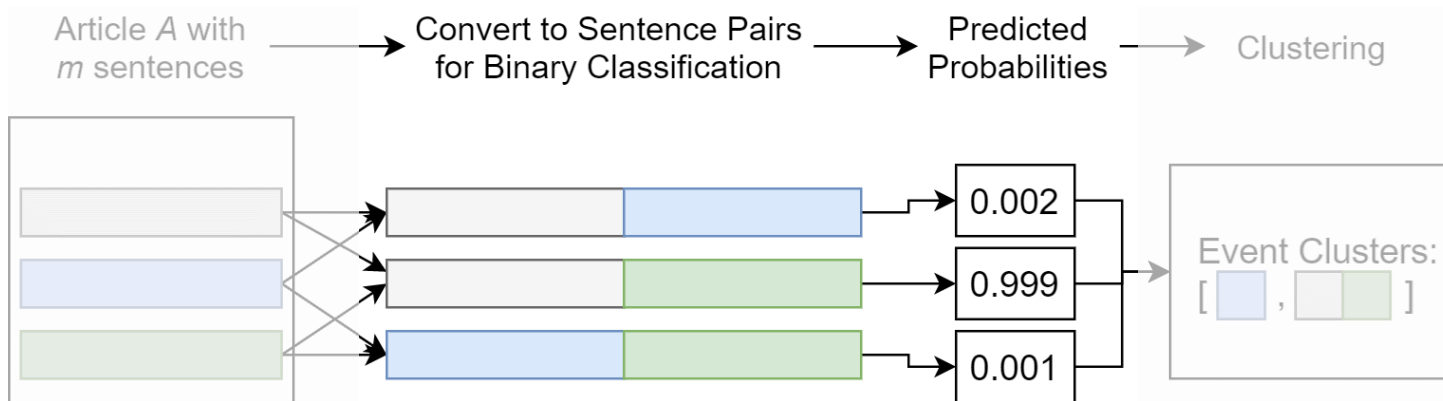

Our approach

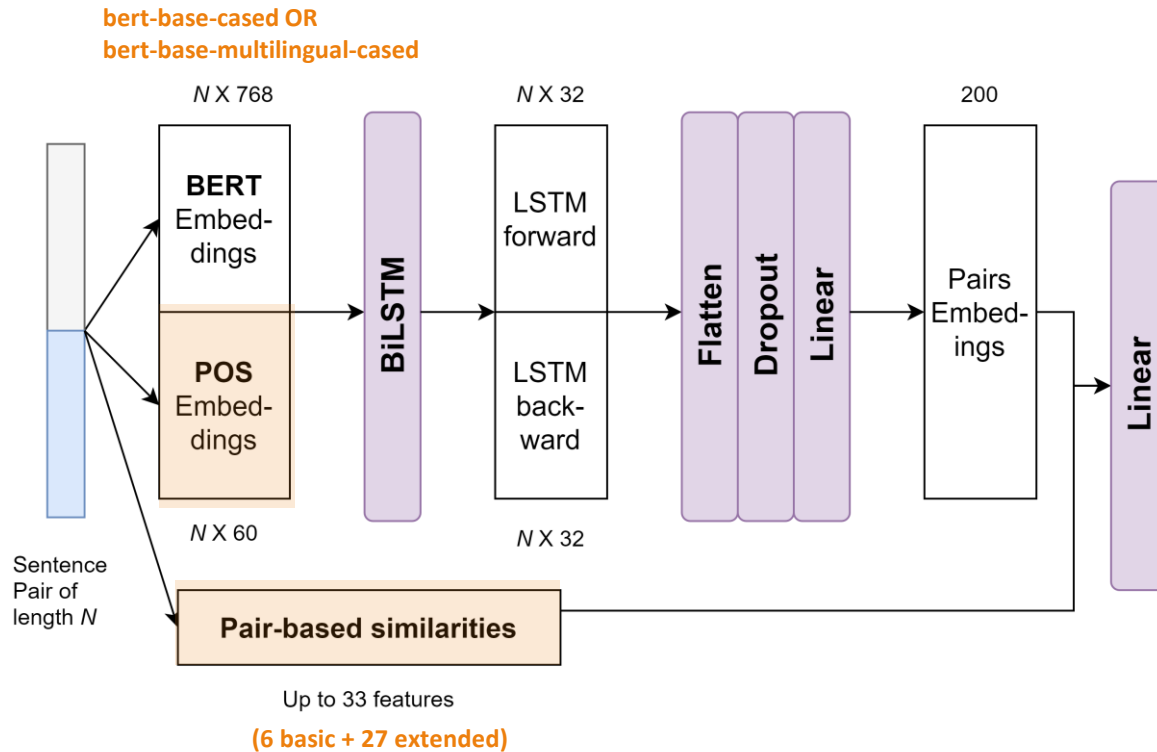

Our approach

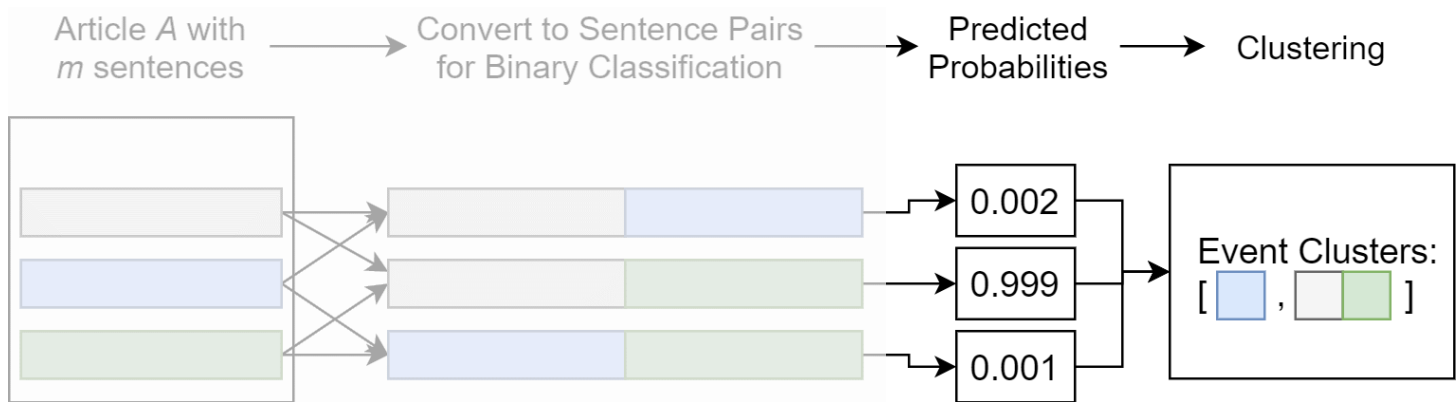

Results

- English settings performs best with all features included; Non-English settings performs better without extended similarities.
- Multilingual BERT performs better for non-English settings, worse-off for English settings.
- Findings from non-English settings will need more data and more work

Average cross-validation set across 5-folds

	CoNLL F_1	ARI		F_1	
		Macro	Micro	Macro	Micro
BERT	84.46	64.73	54.76	68.76	60.82
+ POS embeddings	83.15	56.81	48.94	60.58	54.44
+ Basic similarities	84.31	64.63	55.98	67.54	60.35
+ Extended similarities	84.92	66.78	57.66	70.68	62.94
Multilingual BERT	82.56	59.97	52.64	62.00	55.41
+ POS embeddings	83.98	61.79	52.89	65.59	58.33
+ Basic similarities	82.83	60.62	50.09	64.47	56.20
+ Extended similarities	81.80	57.53	48.74	61.71	54.70

Competition test set

	CoNLL F_1		
	English	Portuguese	Spanish
Best Score in Competition	84.44	93.03	84.23
BERT	80.54	88.85	80.18
+ POS embeddings	77.79	90.58	82.17
+ Basic similarities	77.23	90.21	80.11
+ Extended similarities	81.20	92.18	80.91
Multilingual BERT	77.89	87.22	76.55
+ POS embeddings	79.33	90.92	81.43
+ Basic similarities	78.13	93.03	83.15
+ Extended similarities	76.68	90.36	81.52

Results

Qualitative results

- For documents where all sentences fall into 1 cluster (n=76), almost all had correct predictions (n=72).

Some correct examples:

Example 1

1. Ahmedabad : A mob stoned to death two men who were cycling through Dor Bazaar in Ahmedabad this morning .
2. The victims were passing through the market when they were stopped , beaten up and then stoned to death , said the police .
3. Trouble was also reported from Mirzapur in the city , when a mob gathered near a mosque threw two crude bombs at the police .

Example 2

1. " Fourteen people were arrested on Tuesday for barricading roads in Mothutlung near Brits , " Colonel Sabata Mokgwabone said in a statement .
2. The arrests came after residents took to the streets and barricaded roads .
3. Residents started protesting on Sunday afternoon about a water shortage in Mothutlung .
4. On Monday , two people were killed , allegedly by police , during the protests .

Example 3 -- Actual

1. The leader \s henchmen offered him a " settlement " but when he approached the state Lok Ayukta with a complaint of corruption , they attacked him and his wife .
2. I was threatened that I will also meet the fate of my daughter but Police did not provide any protection to us .
3. On August 8 , about 15 armed goons beat me and my wife mercilessly at my home .
4. RTI activists have been the target of violence in several cases and nine of them have been killed in different parts of the country this year forcing the Centre to consider offering protection to them under the whistleblowers category .

Example 3 -- Predicted

1. The leader \s henchmen offered him a " settlement " but when he approached the state Lok Ayukta with a complaint of corruption , they attacked him and his wife .
2. I was threatened that I will also meet the fate of my daughter but Police did not provide any protection to us .
3. On August 8 , about 15 armed goons beat me and my wife mercilessly at my home .
4. RTI activists have been the target of violence in several cases and nine of them have been killed in different parts of the country this year forcing the Centre to consider offering protection to them under the whistleblowers category .

Example 4 -- Actual

1. As a nationwide commuter rail strike entered its second day on Tuesday , delaying thousands of commuters , Metrorail increased its alternative service in Cape Town to 360 bus journeys .
2. “Metrorail in Cape Town has increased its bus trips to 360 , as an emergency measure for our rail commuters during the ongoing strike by some of our staff , ” Modipane said .
3. 5 percent wage increase for our striking staff remains on the table , ” she said .
4. Earlier the Congress of South African Trade Unions (Cosatu) Western Cape regional secretary , Tony Ehrenreich , said the strike could be resolved for about R1 million a year .
5. This strike is causing huge disruptions and all because of a one percent wage increase .
6. The Cape Town Regional Chamber of Commerce and Industry said the potential effect of the strike was “ so serious ” that there was a case to declare public transport an essential service that could not be disrupted by strike action .
7. “ But we are managing the strike very well , ” Mlangeni said .
8. About 200 workers briefly protested outside the company 's head office in Johannesburg on Tuesday before agreeing to meet again on Wednesday .

id	actual	pred	adjprob
434: (15,18)	1	1	0.9999
434: (12,18)	1	1	0.9999
434: (3,18)	1	1	0.9998
434: (13,29)	1	1	0.9998
434: (1,18)	1	1	0.9998
434: (18,29)	1	1	0.9998
434: (13,15)	1	1	0.9998
434: (3,12)	1	1	0.9998

Example 4 -- Predicted

- 1 1. As a nationwide commuter rail strike entered its second day on Tuesday , delaying thousands of commuters , Metrorail increased its alternative service in Cape Town to 360 bus journeys .
- 3 2. "Metrorail in Cape Town has increased its bus trips to 360 , as an emergency measure for our rail commuters during the ongoing strike by some of our staff , " Modipane said .
- 12 3. 5 percent wage increase for our striking staff remains on the table , " she said .
- 13 4. Earlier the Congress of South African Trade Unions (Cosatu) Western Cape regional secretary , Tony Ehrenreich , said the strike could be resolved for about R1 million a year .
- 15 5. This strike is causing huge disruptions and all because of a one percent wage increase .
- 18 6. The Cape Town Regional Chamber of Commerce and Industry said the potential effect of the strike was " so serious " that there was a case to declare public transport an essential service that could not be disrupted by strike action .
- 29 7. " But we are managing the strike very well , " Mlangeni said .
- 31 8. About 200 workers briefly protested outside the company 's head office in Johannesburg on Tuesday before agreeing to meet again on Wednesday .



THANK YOU.
Questions?

Improving Multilingual Event Sentence Coreference Identification with Linguistic Information

Fiona Anting Tan, Sujatha Das Gollapalli, See-Kiong Ng
 Institute of Data Science, National University of Singapore, Singapore
 tan.f@u.nus.edu, idssdg@nus.edu.sg, seekiong@nus.edu.sg

Task

Event Sentence Coreference Identification aims to cluster sentences that refer to the same event together.

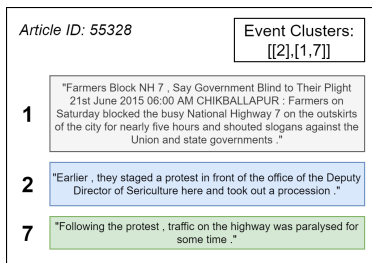

For a given article, our proposed pipeline comprises of an accurate sentence pair classifier that identifies coreferent sentence pairs and subsequently uses these predicted probabilities to cluster sentences into groups. Sentence pair representations are constructed from fine-tuned BERT embeddings plus POS embeddings fed through a BiLSTM model, and combined with linguistic-based lexical and semantic similarities between sentences.

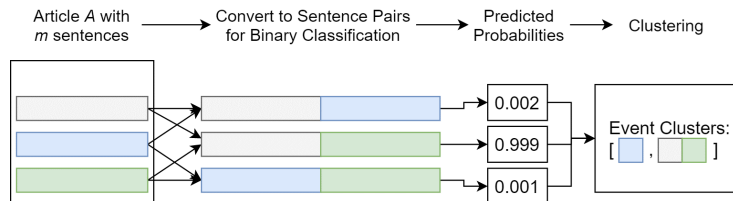

Methodology

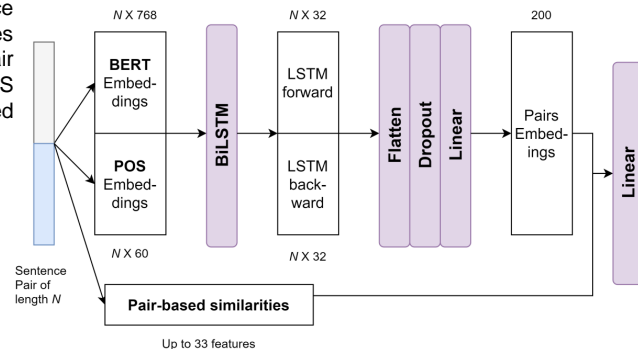

I. Mean cross-validation sets	CoNLL F_1	ARI		F_1	
		Macro	Micro	Macro	Micro
BERT	84.46	64.73	54.76	68.76	60.82
+ POS embeddings	83.15	56.81	48.94	60.58	54.44
+ Basic similarities	84.31	64.63	55.98	67.54	60.35
+ Extended similarities	84.92	66.78	57.66	70.68	62.94
Multilingual BERT	82.56	59.97	52.64	62.00	55.41
+ POS embeddings	83.98	61.79	52.89	65.59	58.33
+ Basic similarities	82.83	60.62	50.09	64.47	56.20
+ Extended similarities	81.80	57.53	48.74	61.71	54.70

II. Competition test set	CoNLL F_1		
	English	Portuguese	Spanish
Best Score in Competition	84.44	93.03	84.23
BERT	80.54	88.85	80.18
+ POS embeddings	77.79	90.58	82.17
+ Basic similarities	77.23	90.21	80.11
+ Extended similarities	81.20	92.18	80.91
Multilingual BERT	77.89	87.22	76.55
+ POS embeddings	79.33	90.92	81.43
+ Basic similarities	78.13	93.03	83.15
+ Extended similarities	76.68	90.36	81.52

Results

Our best models ranked 2nd, 1st and 2nd, and obtained CoNLL F1 scores of 81.20%, 93.03%, 83.15% for the English, Portuguese and Spanish test sets respectively in the ACL-CASE 2021 competition.